

Pilot Operated Regulator

AR425 to 935 Series

Standard Specifications

Model	AR425	AR435	AR625	AR635	AR825	AR835	AR925	AR935
Port size	1/4, 3/8, 1/2		3/4, 1		1 1/4, 1 1/2		2	
Fluid	Air							
Proof pressure	1.5 MPa							
Max. operating pressure	1.0 MPa							
Set pressure range (MPa) ⁽¹⁾	0.05 to 0.83	0.02 to 0.2	0.05 to 0.83	0.02 to 0.2	0.05 to 0.83	0.02 to 0.2	0.05 to 0.83	0.02 to 0.2
Air consumption (for bleed hole) ⁽²⁾	5 L/min (ANR) (at maximum pressure)							
Pressure gauge port size	1/4							
Ambient and fluid temperature	-5 to 60°C (No freezing)							
Construction	Internal pilot relieving type (Pilot air is always bleeding.)							
Weight (kg)	0.7		1.1		2.5		4.5	

Note 1) Outlet pressure range: P2 is 90% of P1 or less.

Note 2) Air consumption differs depending on the set pressure. Due to the construction, the pressure gap between inlet and outlet cannot be set within 0.03 MPa, even if the knob is set at the maximum.

Accessory (Option)/Part No.

Description	Model	Part no.			
		AR4□5	AR6□5	AR8□5	AR9□5
Bracket		B24P	B25P	—	—
Pressure gauge with limit indicator ^{Note 1)}		G46-10-□02 (Max. 1.0 MPa), G46-2-□02 (Max. 0.2 MPa)			

Note 1) • In the gauge part no. (e.g. G46-10-□02), □ indicate kind of the connecting thread. Put nothing for Rc and "N" for NPT thread.

• Please consult with SMC for NPT pressure gauge.

Note 2) Use caution not to tighten excessively when mounting a pressure gauge, otherwise it may result in a breakdown. Use a sealant tape for sealing.

Internal pilot operated relieving type regulator

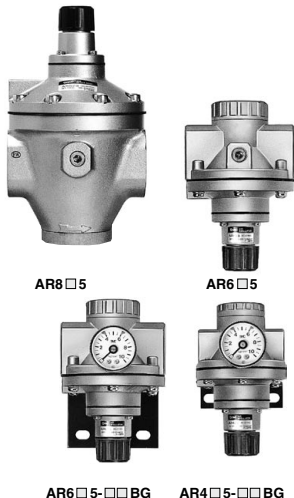

How to Order

Regulator

Body size

4	1/2
6	1
8	1 1/2
9	2

Regulating pressure range

25	0.05 to 0.83 MPa
35	0.02 to 0.2 MPa

Note) Compared with AR□25 type, its adjusting spring will only be changed for 0.2 MPa. It is not the product which does not allow the pressure more than 0.2 MPa.

Port size

02	1/4
03	3/8
04	1/2
06	3/4
10	1
12	1 1/4
14	1 1/2
20	2

Thread type

Nil	Rc
N	NPT
F	G

Accessory

Symbol	Description	Applicable model
Nil	—	—
B	With bracket	AR4□5 to 6□5
G	G46-10-02	AR□25
	G46-2-02	AR□35
P	G46-P10-02-X30	AR□25
	G46-P2-02-X30	AR□35

Note) Pressure display unit: MPa, psi
* Pressure gauges are shipped with regulator, (but not assembled).

Symbol

Pilot Operated Regulator **AR425 to 935 Series**

Flow Rate Characteristics (Representative values)

Inlet pressure: 0.7 MPa

Pressure Characteristics (Representative values)

Conditions:
Inlet pressure: 0.7 MPa
Outlet pressure: 0.2 MPa
Flow rate: 20 L/min (ANR)

AR425 Rc 1/2

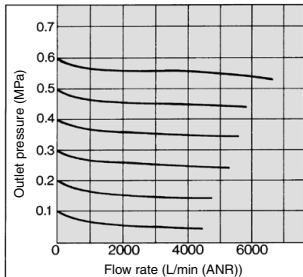

AR435 Rc 1/2

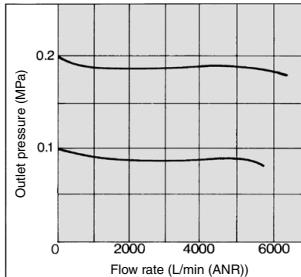

AR425/435 Rc 1/2

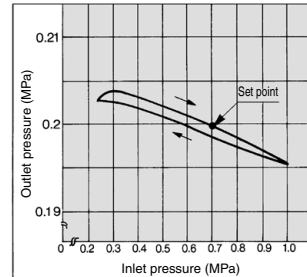

AR625 Rc 1

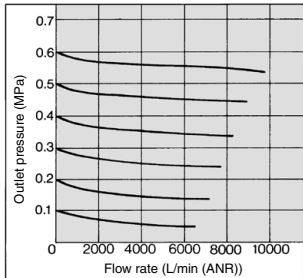

AR635 Rc 1

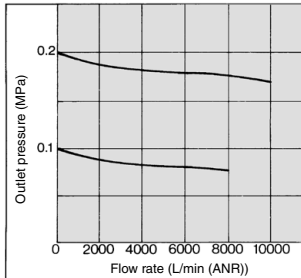

AR625/635 Rc 1

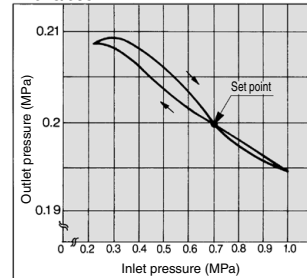

AR825 Rc 1 1/2

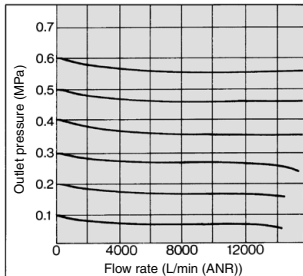

AR835 Rc 1 1/2

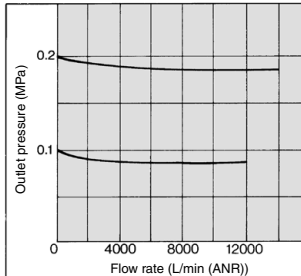

AR825/835 Rc 1 1/2

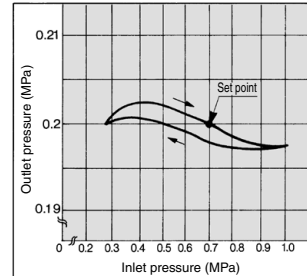

AR925 Rc 2

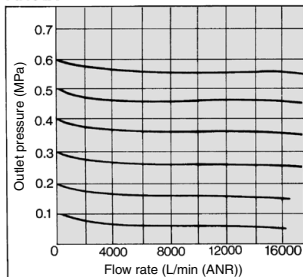

AR935 Rc 2

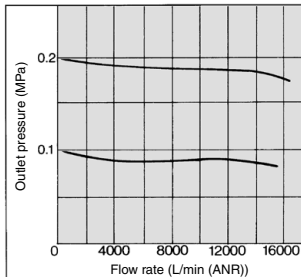

AR925/935 Rc 2

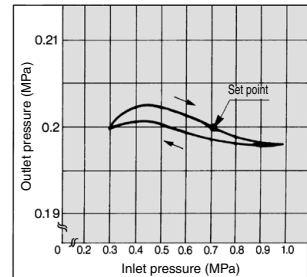

ARJ

AR425 to 935

ARX

AMR

ARM

ARP

IR□-A

IR

IRV

VEV

SRH

SRP

SRF

ITV

IC

ITVH

ITVX

PVQ

VY1

VBA

VBAT

AP100

AR425 to 935 Series

Construction

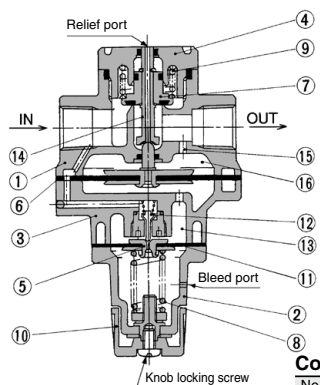

When knob ⑩ is turned clockwise to compress pressure adjustment spring ⑧, the pressure from the IN side passes through diaphragm ⑪, opens pilot valve ⑫, and enters upper pilot chamber ⑬. This pressure and the force generated by pressure adjustment spring ⑧ act as resistance, resulting in equilibrium. Then, this pressure passes through diaphragm ⑥ of the main valve and stem ⑭, and pushes valve (main valve) ⑦ open, thus guiding the pressure to the OUT side. At the same time, the pressure passes through feedback hole ⑮, and enters diaphragm chamber ⑯, thus establishing the OUT side pressure (outlet pressure).

Component Parts

No.	Description	Material	Note
1	Body	Aluminum die-casted *	Platinum silver painted
2	Bonnet	Aluminum die-casted	Platinum silver painted
3	Chamber	Aluminum die-casted	Platinum silver painted
4	Valve guide	Zinc die-casted *	Platinum silver painted

* In the case of AR825/835/925/935, the material is aluminum alloy.

Replacement Parts

No.	Description	Material	Qty.	Part no.			
				AR425, 435	AR625, 635	AR825, 835	AR925, 935
5, 11	Exhaust valve assembly <small>(Note)</small>	—	1	132586A	132586A	132586A	132586A
6	Main valve side diaphragm assembly	—	1	132581A	132659A	13275A	13285A
7	Valve assembly	—	1	132572A	132653A	132752A	132829A
8	Adjusting spring	Steel wire	1	135053 (AR425) 135025 (AR435)	135053 (AR625) 135025 (AR635)	135053 (AR825) 135025 (AR835)	135053 (AR925) 135025 (AR935)
9	Valve spring	Stainless steel	1	135211	132656	132713	13289
10	Knob	ABS	1	13414			

Note) Diaphragm is included.

Precautions

Be sure to read this before handling the products. Refer to back page 50 for Safety Instructions and pages 387 to 391 for Precautions on every series.

Mounting/Adjustment

Warning

1. Install the valve guide (on the opposite side of the knob) 60 mm away from the ground surface to facilitate maintenance inspection.
2. Do not use the regulator with flow exceeding the Max. flow indicated in "Flow Rate Characteristics" as this can cause failure in pressure adjustment.

Caution

1. Release the lock to adjust the pressure. After the adjustment, engage the lock. Failure to observe this procedure could damage the knob or cause the outlet pressure to fluctuate.
<Lock operating method>
Loosen the knob locking screw to unlock it, and tighten it to lock it.
2. Please contact SMC if this product is to be used between solenoid valve and actuator.

Selection

Caution

1. When operating at an inlet pressure lower than the inlet pressure used in the flow rate characteristics graph, the pressure drop on the outlet side may be greater. Therefore, be sure to conduct testing using the actual equipment.
For pressure control equipment selection, refer to page 123 in the "Product Selection Guide."

Dimensions

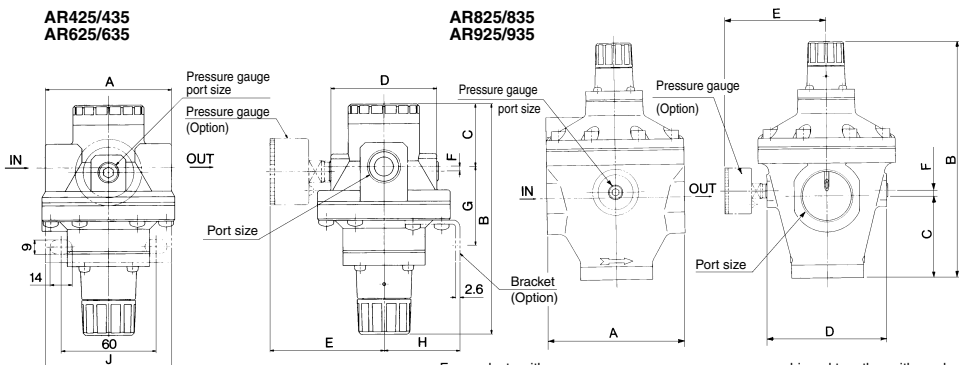

* For products with pressure gauge, pressure gauges are shipped together with product.

Model	Port size	Pressure gauge port size	Bracket dimensions							Bracket part no.		
			A	B	C	D	E	F	G		H	J
AR425/435	1/4, 3/8, 1/2	1/4	80	145.5	39.5	67	73	3	50.0	48	80	B24P
AR625/635	3/4, 1	1/4	98	155	43	78	78.5	7	85	52	90	B25P
AR825/835	1 1/4, 1 1/2	1/4	126	216	75	110	94.5	5	—	—	—	—
AR925/935	2	1/4	160	241	90	140	109.5	10	—	—	—	—